

6 MEN'S RESTROOM  
A401 SCALE: 3/8" = 1'-0"

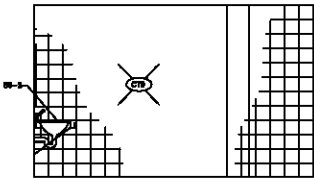

7 MEN'S RESTROOM  
A401 SCALE: 3/8" = 1'-0"

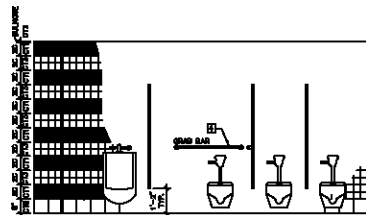

8 MEN'S RESTROOM  
A401 SCALE: 3/8" = 1'-0"

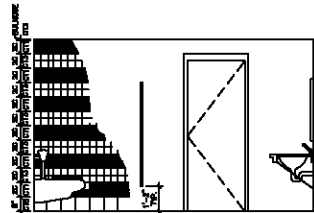

9 MEN'S RESTROOM  
A401 SCALE: 3/8" = 1'-0"

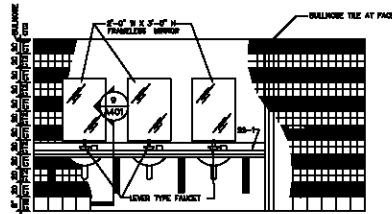

7 WOMEN'S RESTROOM  
A401 SCALE: 3/8" = 1'-0"

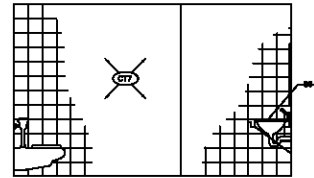

8 WOMEN'S RESTROOM  
A401 SCALE: 3/8" = 1'-0"

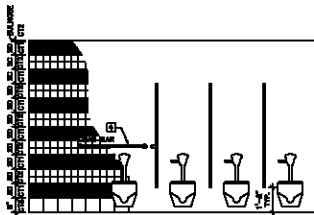

9 WOMEN'S RESTROOM  
A401 SCALE: 3/8" = 1'-0"

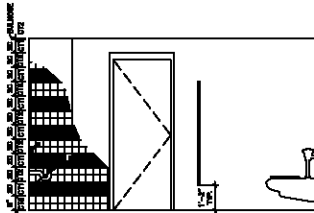

10 WOMEN'S RESTROOM  
A401 SCALE: 3/8" = 1'-0"

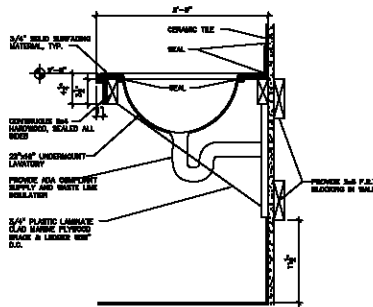

11 LAVATORY COUNTER  
A401 SCALE: 1 1/2" = 1'-0"

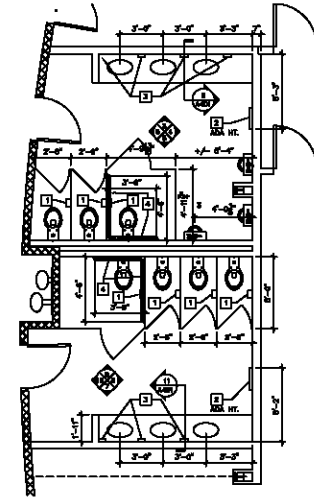

1 FIRST FLOOR RESTROOM PLAN  
A401 SCALE: 1/4" = 1'-0"

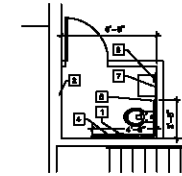

2 SECOND FLOOR RESTROOM PLAN  
A401 SCALE: 1/4" = 1'-0"



ELKIN / SOBOLTA & ASSOCIATES  
19 PARK AVENUE, SUITE 200  
ROCKFORD, ILL. 61107  
TEL: 815.393.3511 FAX: 815.393.5752

MICHAEL A. ELKIN, AIA  
SUSAN M. SOBOLTA, AIA

MICHAEL A. SOBOLTA, AIA  
22 E. LEXINGTON

STRUCTURAL ENGINEER  
ALLIED ENGINEERING, INC.  
87 HANCOCK STREET, SUITE 200  
WOODS HOLE, MA 01994

MECHANICAL/ELECTRICAL ENGINEER  
A/C DESIGN  
75 BRAYLE AVENUE, SUITE 100  
WOODS HOLE, MA 01994

COPYRIGHT 2004 BY MICHAEL A. SOBOLTA AND ASSOCIATES  
THIS DOCUMENT IS THE PROPERTY OF E.S.A. ARCHITECTS AND ASSOCIATES. NO PART OF THIS DOCUMENT MAY BE REPRODUCED OR TRANSMITTED IN ANY FORM OR BY ANY MEANS, ELECTRONIC OR MECHANICAL, WITHOUT THE WRITTEN APPROVAL OF E.S.A. ARCHITECTS.

1	DATE	ISSUED FOR REVIEW	DATE	REVISION

LYNDHURST RECREATION CENTER

OWNER  
CHEROKEE NORTHEAST, LLC  
ONE WINDSORLAND PLACE  
LAKE WATKINS, MA 01752

DRAWING TITLE  
ENLARGED RESTROOM PLANS

MARK	MANUFACTURER	MODEL NUMBER	DESCRIPTION
1			TOILET TISSUE DISPENSER, BY OWNER
2			ROLL TOWEL BY OWNER, SEE NOTE D
3			
4	BOBROCK	B-86137-00	36" x 54" LONG GRAB BAR
5			
6	BOBROCK	B-8112	WALL MOUNTED SOAP DISPENSER
7	BOBROCK	B-185-2436	WALL MOUNTED CHANNEL FRAME MIRROR

- NOTES:  
 A. PROVIDE BLOCKING, STRAPPING AND GROUNDS AS REQUIRED FOR SECURE ATTACHMENT OF TOILET ACCESSORIES.  
 B. ALL MOUNTING LOCATIONS SHALL CONFORM TO THE LATEST ADAAG REQUIREMENTS.  
 C. ALL TOILET ACCESSORIES SHALL BE SEALED TO SUBSTRATE WITH CLEAR SILICONE SEALANT.  
 D. MOUNT ONE UNIT AT ADA RECOMMEND HEIGHT, SECOND UNIT AT 6'-0" A.F.F. TO TOWEL DISPENSER LEVEL.